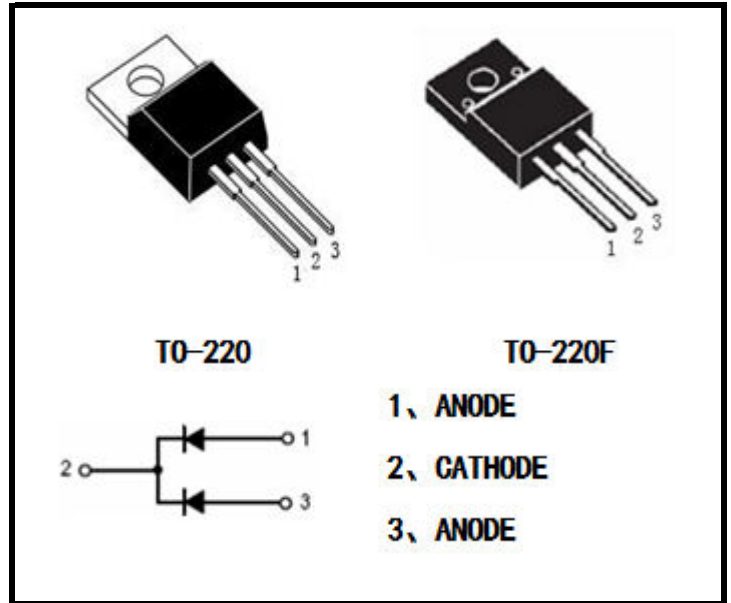

Ultra Low VF=0.29V at IF=5A
FEATURES

- * Schottky Barrier Chip
- * Guard Ring Die Construction for Transient Protection
- * Low Power Loss, High Efficiency
- * High Surge Capability
- * High Current Capability and Low Forward Voltage Drop
- * For Use in Low Voltage, High Frequency Inverters, Free Wheeling, and Polarity Protection Applications

PACKAGE

ELECTRICAL CHARACTERISTICS (Tamb=25°C)

Characteristic	Symbol	Value	Unit	
Peak Repetitive Reverse Voltage	V_{RRM}	60	V	
Working Peak Reverse Voltage	V_{RWM}			
DC Blocking Voltage	V_R			
Average Rectifide Output Current	$I_{F(per\ leg)}$	20	A	
	$I_{F(Total)}$	40		
Non-Repetitive Peak Surge Current (Surge applied at rated load conditions halfwave, single phase, 60Hz)	I_{FSM}	400	A	
Instaneous Forward Voltage @IF=5A, TC=25°C @IF=20A, TC=25°C @IF=5A, TC=125°C @IF=20A, TC=125°C	V_F	TYP.	V	
		0.38		
		0.54		
		0.29		
Peak Reverse Current @Tc=25 °C at Rated DC Blocking Voltage @Tc=125°C	I_R	0.3	mA	
		100		
Operating and Storage Temperature Range	T_J, T_{STG}	-65 to +150	°C	
Maximum Thermal Resistance	θ_{JC}	TO-220	2	°C/W
		TO-220F	4	
	θ_{JA}	TO-220	60	
		TO-220F	60	

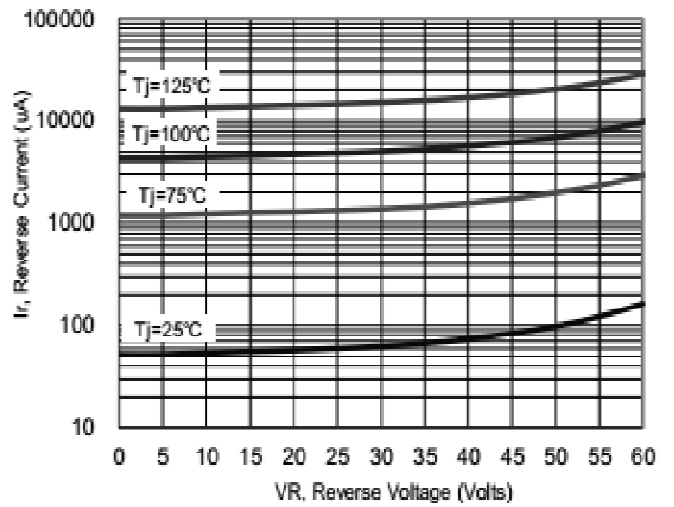
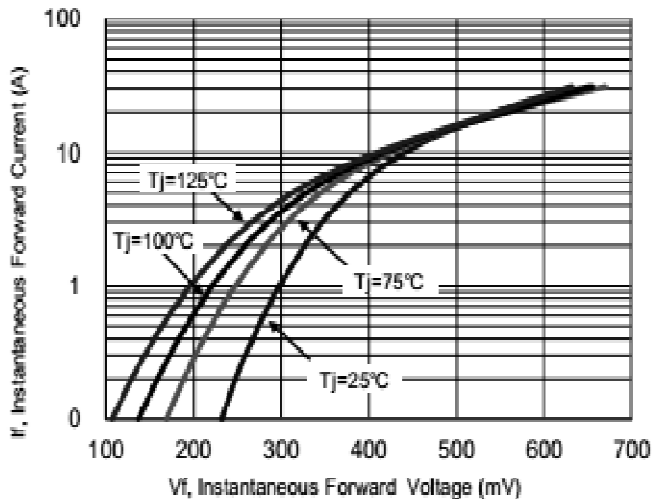
Characteristics Curves



Typical Forward Voltage Per Diode

Typical Reverse Current Per Diode

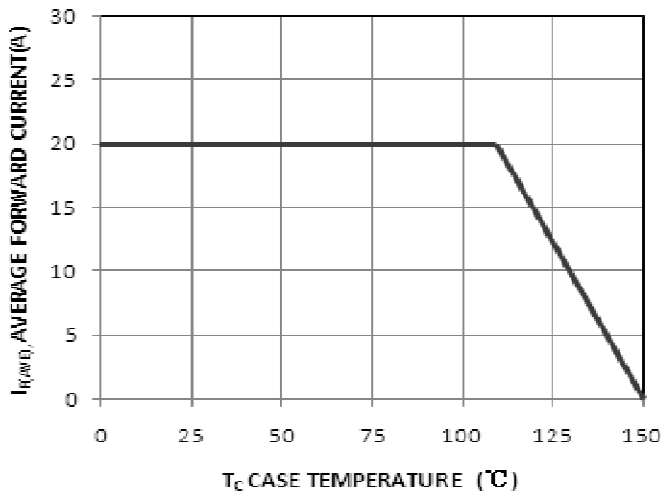

Average Forward Current vs. Case Temperature Per Diode

■ Reflow Soldering Temperature Profile

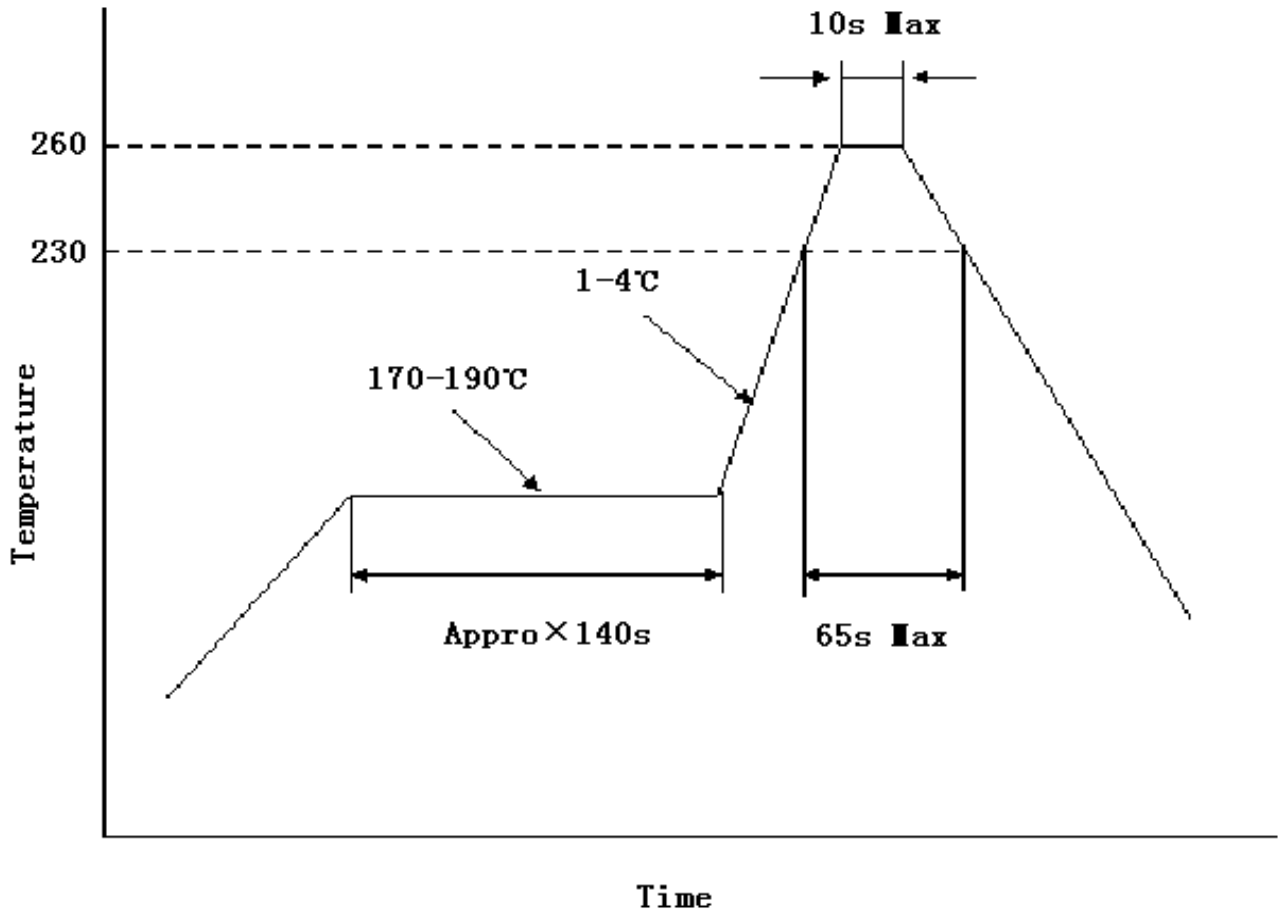

T0-220 MECHANICAL DATA

UNIT: mm

SYMBOL	MIN	NOM	MAX	SYMBOL	MIN	NOM	MAX
A	4		4.8	e	2.44	2.54	2.64
B	1.2		1.4	F	1.1		1.4
B1	1		1.4	L	12.5		14.5
b1	0.75		0.95	L1	3	3.5	4
c	0.4		0.55	ΦP	3.7	3.8	3.9
D	15		16.5	Q	2.5		3
D1	5.9		6.9	Q1	2		2.9
E	9.9		10.7				

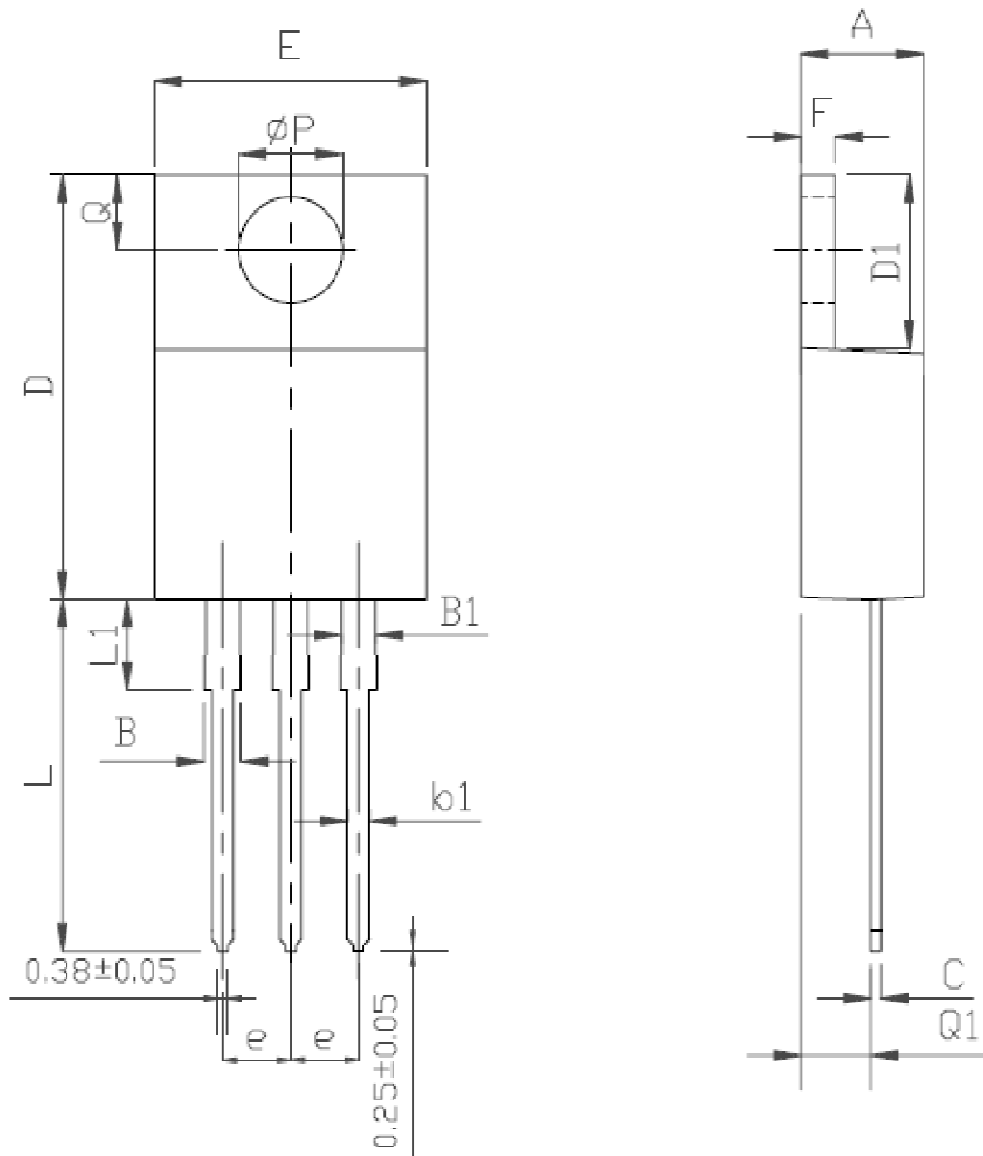

TO-220F MECHANICAL DATA

UNIT: mm

SYMBOL	MIN	NOM	MAX	SYMBOL	MIN	NOM	MAX
A	4.5		4.9	E1	6.5	7	7.5
A1	2.3		2.9	e	2.44	2.54	2.64
b	0.65		0.9	L	12.5		14.3
b1	1.1		1.7	L1	9.45		10.05
b2	1.2		1.4	L2	15		16
c	0.35		0.65	L3	3.2		4.4
D	14.5		16.5	ΦP	3		3.3
D1	6.1		6.9	Q	2.5		2.9
E	9.6		10.3				

